











PARTICOLARE A



PARTICOLARE D

## LEGENDA

-  pompa solare
-  vaso espansione solare
-  valvola a sfera
-  valvola di sicurezza
-  manometro
-  termometro
-  valvola di ritegno
-  punti di sfiato
-  alimentazione da acquedotto
- ① circuito solare
- ② circuito riscaldamento
- ③ circuito sanitario

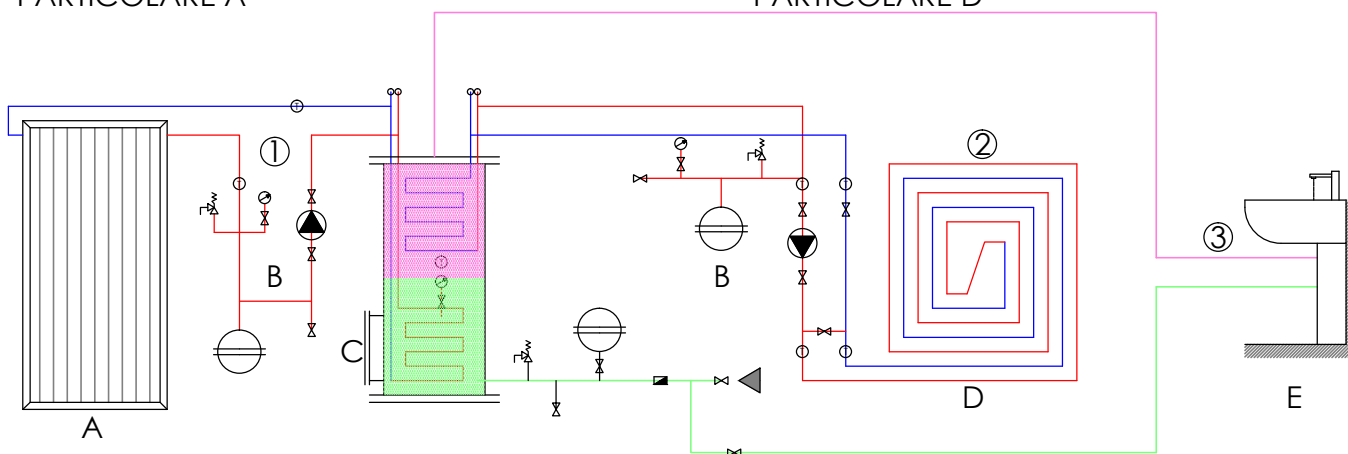

PARTICOLARE B



PARTICOLARE C



PARTICOLARE E

SCHEMA MODELLINO  
IMPIANTO SOLARE

anno formativo 2013/14

CLASSI SECONDA E TERZA

OPERATORE TERMIDRAULICO

Via 1° Maggio, 8 - 23868 VALMADRERA (LC)

Telefono 0341.580359 - 0341.202057 - Telefax 0341.200364

www.cfpaldomoro.it - e-mail: info@cfpaldomoro.it

